

MTS 3100 Mastertech®

Operator's Manual

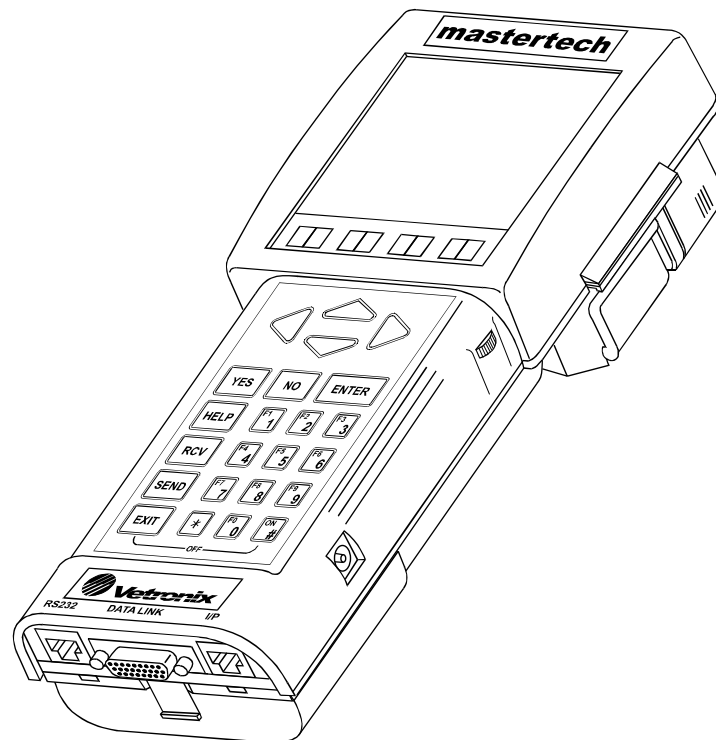

Vetronix Corporation

Copyright © 2002

Manual P/N 02003077

Tech 1, Tech 1A, and Mastertech[®] are registered trademarks of Vetronix Corporation

Printed in USA 3/02

This entire document and all information contained herein are proprietary, confidential, and exclusive trade secret property of Vetronix Corporation, and shall not be reproduced, duplicated, or copied in whole or in part, or made available to any person, firm, or corporation without the prior written permission of Vetronix Corporation.

FCC Compliance

This equipment has been tested and found to comply with the limits for a Class B digital device, pursuant to Part 15 of the FCC Rules. These limits are designed to provide reasonable protection against harmful interference when the equipment is operated in a residential installation. This equipment generates, uses and can radiate radio frequency energy and, if not installed and used in accordance with the instruction manual, may cause harmful interference to radio communications. However, there is no guarantee that interference will not occur in a particular installation. If this equipment does cause harmful interference to radio or television reception, which can be determined by turning the equipment off and on, the user is encouraged to try to correct the interference by one or more of the following measures:

- Re-orient or relocate the receiving antenna.
- Increase the separation between the equipment and receiver.
- Connect the equipment into an outlet on a circuit different from that to which the receiver is connected.
- Consult the dealer or an experienced radio/TV technician for help.

Foreword

The Mastertech Multi-Function Tester and associated Program Card(s) are designed for use by trained service personnel to diagnose and repair automotive electronic systems. Every attempt has been made to provide complete and accurate technical information based on factory service information available at the time of publication. However, the right is reserved to make changes at any time without notice.

To familiarize yourself with the Mastertech and Program Card capabilities and how to use them, please read through the operator's manuals before putting the Mastertech and program card(s) to work. The tools are designed to reduce time-consuming reference to manuals as much as possible. Once familiar with the tools and their operation, you will be able to spend more time diagnosing and less time reading.

The Mastertech Multi-Function Tester and Program Card(s) provide the following capabilities:

- Data scan functions
- Bi-directional serial data commands
- Meter measurement functions
- Oscilloscope
- Operate as the center of an automotive diagnostic system
- Shop management functions
- Math functions and unit conversions
- Timer functions
- Future expandability

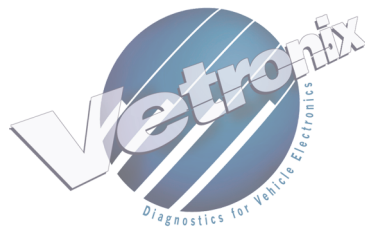

Table of Contents

1. INTRODUCTION	1-1
USING THE MASTERTECH	1-1
<i>Screen Displays in this Manual</i>	1-1
<i>Location of Vehicle ECUs and Test Connectors</i>	1-2
<i>Tester Keypad</i>	1-2
WARNINGS, CAUTIONS, NOTES	1-2
<i>Operating Precautions</i>	1-2
<i>Data Memory Retention</i>	1-3
WARRANTY AND REPAIR	1-3
<i>Warranty</i>	1-3
<i>Repair Service</i>	1-4
<i>Vetronix Service Centers</i>	1-4
<i>USA</i>	1-4
<i>Canada</i>	1-4
2. DIAGNOSTIC CAPABILITIES	2-1
MASTERTECH KIT OVERVIEW	2-1
<i>The Mastertech</i>	2-1
3. MASTERTECH KIT COMPONENTS	3-1
MASTERTECH FEATURES	3-2
PROGRAM CARDS AND CARTRIDGES	3-3
<i>Program Cards</i>	3-3
<i>Tech 1 Cartridges</i>	3-3
<i>I/O Cartridges</i>	3-3
KEYPAD	3-4
MASTERTECH KEY FUNCTIONS	3-5
DISPLAY	3-6
DATA LINK CONNECTOR AND CABLE	3-6
VEHICLE ADAPTERS	3-6
POWER SOURCES	3-7
BATTERY BACKED OPERATION	3-7
BATTERY BACKED MEMORY	3-7
BEEPER	3-7
LEDS	3-8
INSTRUMENTATION PORT AND DEVICES	3-9
DIAGNOSTIC TEST LEADS	3-10
RS232 PORT AND RS232 PORT DEVICES	3-11
<i>Remote Host Computer</i>	3-11

Printer	3-12
MASTERTECH CHARACTERISTICS	3-13
4. ACTIVATING THE BATTERY BACKED MEMORY	4-1
5. GETTING STARTED	5-1
INSTALLING A PROGRAM CARD OR CARTRIDGE	5-1
Program Card	5-1
Tech 1 or I/O Cartridge	5-1
CONNECTING THE TESTER TO THE VEHICLE	5-2
POWERING THE TESTER	5-4
Vehicle Battery	5-4
AC 12-Volt Power Supply	5-4
Battery Pack	5-4
TURNING THE TESTER ON AND OFF	5-5
POWER-UP DISPLAY	5-6
HELP SCREENS	5-6
6. USING THE PORT CONNECTIONS	6-1
RS232 PORT	6-1
INSTRUMENTATION PORT	6-2
DIAGNOSTIC TEST LEADS	6-2
7. FINISHING UP	7-1
CLEANING AND STORING YOUR TESTER	7-1
8. BATTERY CHARGING AND REPLACEMENT	8-1
NICAD BATTERY PACK	8-1
Charging the Battery Pack	8-2
Replacing the NiCad Batteries	8-2
LITHIUM BATTERY	8-4
Replacing the Lithium Battery	8-4
A. UNDERSTANDING RS232 COMMUNICATIONS	A-1
RS232 Interface Signals	A-2
B. IF YOU ARE HAVING A PROBLEM	B-1
Blank Screen When Tester Is Turned On	B-1
Error message is displayed	B-2
Printer cannot print by pressing (SEND) and (#) (SEND) keys	B-2

<i>Mastertech Does Not Pass All Self Tests</i>	B-3
<i>Mastertech Fails to Power Up</i>	B-3
<i>C. GLOSSARY AND ABBREVIATIONS</i>	C-1
<i>INDEX</i>	Index-1



1. INTRODUCTION

USING THE MASTERTECH

The Mastertech Operator's Manual lists the diagnostic capabilities of the tester and describes the hardware components contained within the Mastertech kit.

The Mastertech Operator's Manual also describes how to connect the hand-held tester to the vehicle and how to operate the Mastertech. The Mastertech must be used in conjunction with a diagnostic application program card or TECH 1 cartridge. TECH 1 cartridges are automotive diagnostic application cartridges that can be used in the TECH 1, TECH 1A, and Mastertech testers.

The program card and/or TECH 1 cartridge operator's manuals provide directions for connecting the related components to the Mastertech and the vehicle, and operating instructions for the test modes available in the program card or cartridge. The program card and cartridge operator's manuals should be used in conjunction with the Repair Manual for the vehicle being tested.

SCREEN DISPLAYS IN THIS MANUAL

The data shown in the screen displays in the Mastertech Operator's Manual is sample data for illustration purposes only and may be different from the data displayed when different vehicles are tested.

The sample displays in this manual are full screen displays that are available when using a program card with the Mastertech.

Tech 1 Displays

If you are using a TECH 1 cartridge in the Mastertech without a program card installed, menus and data screens are displayed on four lines with 16 characters on each line. Graphic displays such as Bar Charts, Line Graphs, and Oscilloscope displays are not available.

Enhanced Displays

Most TECH 1 cartridges can be used in conjunction with a program card which enables the tester to display data in full-screen Enhanced Mode. Graphic displays such as Bar Charts, Line Graphs, and Oscilloscope displays are available when operating in Enhanced Mode. The Enhanced Mode is explained in the program card operator's manual.

LOCATION OF VEHICLE ECUs AND TEST CONNECTORS

For the location of vehicle Electronic Control Units (ECUs) and Data Link Connectors (DLCs), refer to the Repair Manual and the electrical wiring diagram for the vehicle being tested.

TESTER KEYPAD

In the Mastertech and Program Card Operator's Manuals, the number, symbol, word, or abbreviation on the Mastertech keys are indicated in boldface type and enclosed in a box. For example, **8**, *****, **#**, **ENTER** and **EXIT**. When two keys are shown together, hold down the first key while pressing the second key. For example, **#** **EXIT** means to press and hold the **#** key, then press the **EXIT** key.

WARNINGS, CAUTIONS, NOTES

In the Mastertech and program card manuals:

- WARNINGS indicate there is a possibility of injury to you or other people.
- CAUTIONS indicate the possibility of damage to the component being repaired.
- NOTES providing additional information are separated from the text but do not appear in bold.

Refer to the Repair Manual for the vehicle being tested for further Warnings, Cautions, and Notes.

OPERATING PRECAUTIONS

WARNING!



When performing any checks with the engine running in an enclosed space such as a garage, be sure there is proper ventilation. Never inhale exhaust gases; they contain carbon monoxide, a colorless, odorless, extremely dangerous gas which can cause unconsciousness or death.

CAUTION!



Do not use the Diagnostic Test Leads to check voltages higher than 20 volts. (Don't plug the Diagnostic Test Leads into a standard AC wall outlet). Also, the Diagnostic Test Leads should be kept away from high tension secondary ignition wires when the engine is cranking or running.

NOTE

Do not remove or install a program card or cartridge while power is applied to the Mastertech. If you wish to change or add a program card or cartridge, first turn the tester off by pressing (#) **EXIT**.

DATA MEMORY RETENTION

Data that has been captured by the tester can be replayed, printed on a printer, or transferred to a computer for further analysis. The data will be retained within the Mastertech memory as long as the Lithium battery provides the proper power or until the data is erased.

NOTE

If the Mastertech is turned on without a program card or cartridge installed, or with a different program card or cartridge installed, the data stored in the tester memory, such as set-up information and Snapshot data, will be lost.

WARRANTY AND REPAIR

WARRANTY

The Mastertech is warranted by Vetronix Corporation to the original consumer to be free of defects in material and workmanship for two years. Cables, adapters, cartridges, and program cards are warranted for a period of one year.

The warranty period is from the date of shipment to the original consumer. If a product is found to be defective during this period, the product can be returned to an authorized Vetronix Service Center and Vetronix Corporation will repair or replace the unit free of charge. This warranty does not cover any part that has been abused, altered, used for a purpose other than that which it was intended, or used in a manner inconsistent with instructions regarding its use including but not limited to the following:

- Damage due to improper product operation or product modification.
- Damage due to use of non-Vetronix supplied cables and accessory items, or unauthorized peripheral equipment.
- Damage due to dropping or other severe impact to the product.
- Damage due to exposure to excessive temperatures.
- Damage or loss that may occur during shipping

This warranty also excludes all incidental or consequential damages.

REPAIR SERVICE

If you experience a problem with the Mastertech or program card, read the Operator's Manual carefully to make sure that you are operating the unit properly. To avoid the inconvenience of returning a non-defective unit for repair, it is advisable to exercise the Self Test procedures outlined in the Mastertech Operator's Manual to find out if there is a problem with the unit.

If it is determined that a problem exists, call a Vetronix Service Center (or authorized Vetronix Service Agent). A service technician will attempt to identify the nature of the problem and recommend a course of action. If the unit requires repair, package the Mastertech and program card, along with all cables and adapters, and send it freight prepaid to the repair service center listed for the country in which you live. Please enclose a note which provides the date of purchase, a brief explanation of the problem, and your return address. (No CODs, please.)

When the unit is received at the Vetronix Service Center it will be diagnosed, repaired or replaced, and returned. If the unit is determined to be in warranty, it will be repaired or replaced with no charge and returned freight prepaid.

If the unit is determined to be out of warranty, it will be repaired for a nominal service charge plus return freight.

VETRONIX SERVICE CENTERS

USA

VETRONIX CORPORATION
2030 Alameda Padre Serra
Santa Barbara, CA 93103 USA
TEL: 805-966-2000
FAX: 805-965-3497

CANADA

VETRONIX REPAIR SERVICE
c/o Custone Electromotive Inc.
1150 Champlain Court
Whitby, Ontario L1N 6A8
905-668-2664

2. DIAGNOSTIC CAPABILITIES

MASTERTECH KIT OVERVIEW

The Mastertech kit consists of a hand-held tester and attachments, which allows the use of one tool for many automotive diagnostic applications. The Mastertech kit is designed so that future automotive diagnostic applications can easily be incorporated into the existing tester.

The diagnostic capabilities of the tester components are described in this chapter. A description of the hardware related to each component is included in the following sections.

THE MASTERTECH

The Mastertech is used by professional technicians as an aid in diagnosing and repairing automotive electrical and electronic systems. It is designed to test Engine Control Modules (ECMs) and Electronic Control Units (ECUs) for brake, body, and chassis systems, and their associated sensors, actuators, and cable harnesses.

Capable of operating either as a stand-alone tool or as the control unit for the toolset, the Mastertech employs plug-in program cards and cartridges, and can be adapted to operate with virtually all automotive electronic systems from the simplest to the most complex.

The tester supports diagnosis of electronic systems on most US vehicles, as well as many European and Asian manufactured vehicles.

The Diagnostic Test Leads supplied with the Mastertech kit provides additional troubleshooting capabilities. The Diagnostic Test Leads are used as inputs to a smart digital volt meter (DVM) function to monitor input/output signals between the ECM/ECU and sensors and actuators, and for inputs to the oscilloscope function.

When the appropriate program card and/or cartridge is installed and the tester is connected to a vehicle's Data Link Connector (DLC), the following diagnostic functions are available:

- Display ECM/ECU Data List parameters
- Display stored trouble codes and descriptions

- Display input sensor read data
- Control actuator output data
- Display ON/OFF status of switch signals
- Test feed-back systems such as the O2 sensor
- Command clearing of some ECM/ECU trouble codes
- Troubleshoot using the Diagnostic Test Leads
- Troubleshoot intermittent problems with Snapshot mode
- Print test results to provide a permanent record

3. MASTERTECH KIT COMPONENTS

Mastertech kits are available with a variety of components. The items listed below are either included in the Mastertech kit, or are available as accessories through Vetronix Corp.

- Mastertech Multi-Function Tester
- Multi-Function Tester Program Card
- Diagnostic Test Lead Set
- Diagnostic Test Lead Adapter
- Data Link Connector (DLC) Cable
- DC Power Cable
- DLC Self Test Adapter
- RS232/IP Self Test Adapter
- GM 12/14 Pin DLC Adapter
- Ford 7/14 Pin Adapter
- Chrysler 6/14 SCI DLC Adapter
- GM 5-Pin Adapter
- GM Pin-E Adapter
- AC Power Supply
- Mastertech Boot
- Mastertech Operator's Manual
- Program Card Operator's Manual
- Storage Case

MASTERTECH FEATURES

The Mastertech Multi-Function Tester can be hand-held or placed on a flat surface. An adjustable hand strap on the back provides added security while holding the tester.

A built-in support stand allows the tester to be tilted to the most convenient viewing angle when it is not handheld.

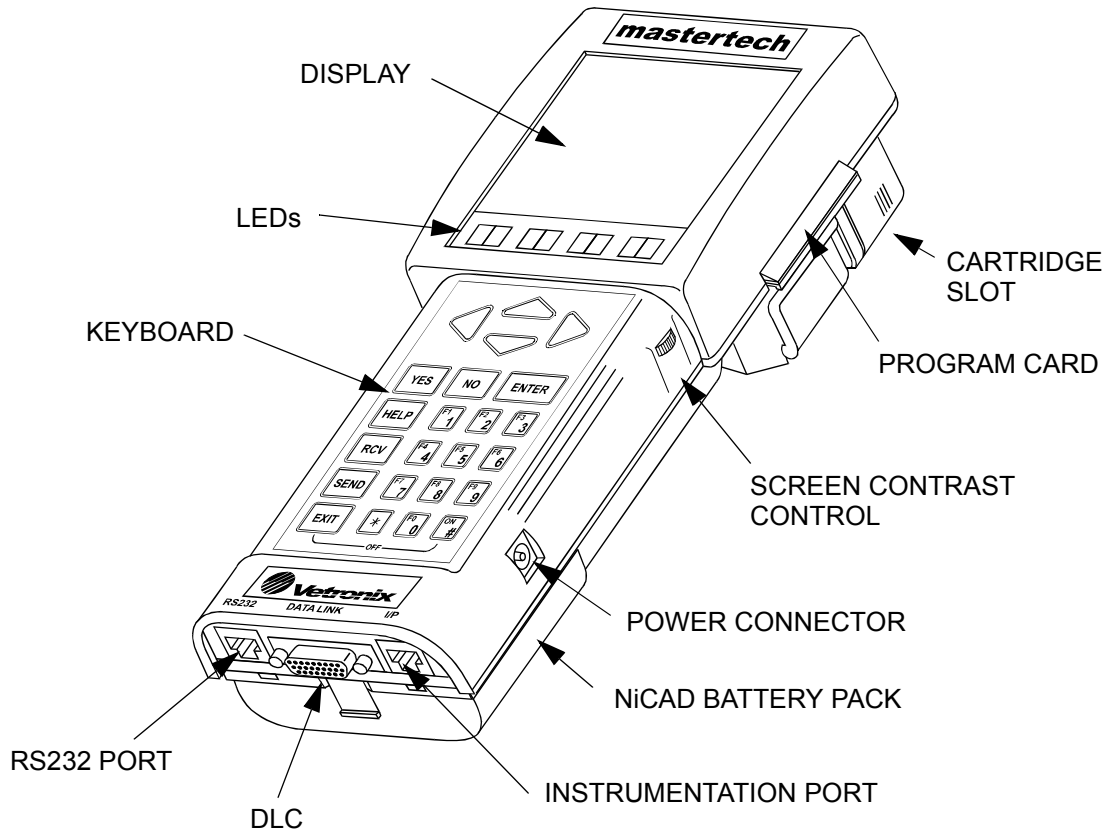

FIGURE 3-1. Tester Features

PROGRAM CARDS AND CARTRIDGES

The Mastertech uses plug-in program cards and cartridges which contain the software programs for testing specific vehicles and systems. The program cards and cartridges are upgraded periodically to include new vehicles, model years, and systems. Specific operating instructions are provided for diagnostic test functions contained in the program cards or cartridges.

Program cards, TECH 1 cartridges, and Input/Output (I/O) cartridges can be used with the Mastertech Multi-Function Tester.

PROGRAM CARDS

Multiple program cards may be required to provide the complete diagnostic testing capabilities of the toolset. Program cards are installed in the slot on the upper right side of the tester (below the display). The program card slot is keyed so the card can only be installed in the proper orientation.

TECH 1 CARTRIDGES

Most cartridges designed for use with a TECH 1 or TECH 1A tester are fully compatible with the Mastertech. TECH 1 cartridges plug into the cartridge slot and allow you to test most US vehicles as well as many European and Asian manufactured vehicles.

I/O CARTRIDGES

Input/Output (I/O) cartridges are used to expand the I/O capability of the tester. I/O cartridges plug into the cartridge slot at the top rear of the tester.

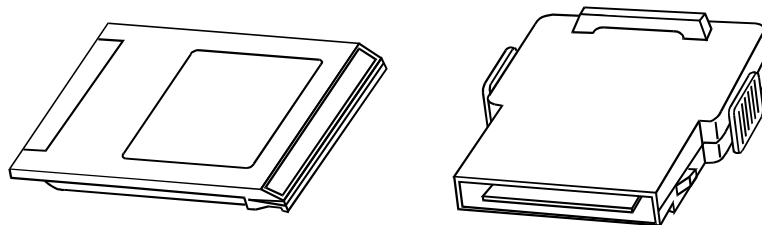

FIGURE 3-2. Program Card and Tech 1 Cartridge

KEYPAD

The 27-key keypad allows you to make menu selections or input information. Through the keypad you can select the data you want to see and choose the display format. While performing some tests you can control the operation of certain functions through the keypad.

The ***** and **#** keys are used to modify other keys. For example, if the instructions say press **#** **EXIT**, press the **#** key first and hold it down while pressing the **EXIT** key.

Some keys, such as the numeric **(0) - (9)** and **YES** and **NO** keys, have different functions depending on which test mode is in use. The **HELP** key displays a list of the active keys and their functions in the current test mode.

A chart of the keys and their functions is illustrated in [Figure 3-3](#).

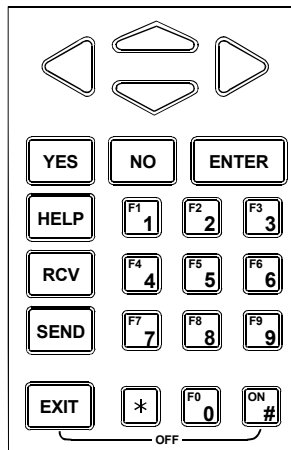

FIGURE 3-3. Mastertech Keypad

MASTERTECH KEY FUNCTIONS

KEY	FUNCTION
* and #	Similar to the shift key on a typewriter, the * and # keys are used in conjunction with other keys as a modifier. Press the * or # key and hold it down while you press the second key. For example, # EXIT .
ON	Turn the tester on.
# EXIT	Turn the tester off.
▽, △	Move the cursor (highlight) on the display up or down.
◀, ▶	Move the cursor (highlight) on the display left or right.
YES , NO	Answer questions asked on the tester display. Display and select data parameters to monitor.
ENTER	Confirm information on the tester display. Terminate a numeric entry. Move ahead in procedures. Select a highlighted menu entry.
HELP	Display a list of the active keys and a summary of the functions.
RCV	Receive input from an external device.
SEND	Send information (data only) to an external device such as a printer.
# SEND	Screen Print. Sends the current display to a printer.
EXIT	Return to a previous step in procedures. Return to normal operation after the HELP key has been pressed.
0 - 9	Used to select and control modes. Input data to the tester and designate trouble codes.
F0 - F9	Used as function keys.

DISPLAY

The 3" x 3" display allows data to be viewed in several graphic modes and text modes using large and small character sizes. The tester can display data using real-time bar graphs, line graphs, or data lists for several parameters at the same time. Additional modes include oscilloscope and TECH 1 displays.

The display contrast can be adjusted by turning the thumb wheel on the right side of the tester.

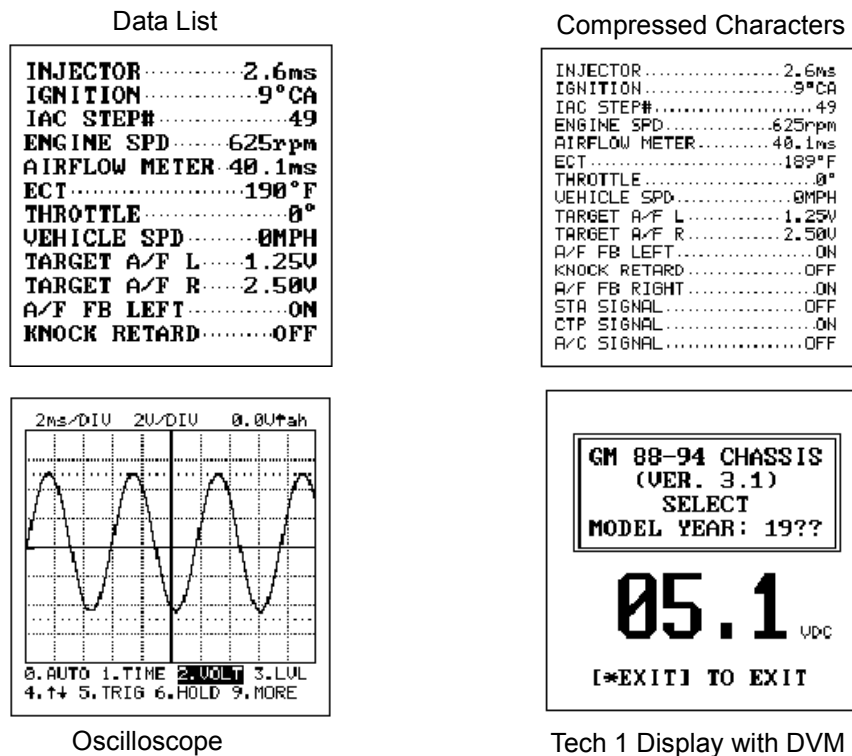

FIGURE 3-4. Mastertech Display Examples

DATA LINK CONNECTOR AND CABLE

Communication between the tester and the vehicle's electronic systems is through the heavy duty 14-pin to 26-pin Data Link Connector (DLC) cable that is connected to the bottom center of the tester.

VEHICLE ADAPTERS

Adapters for connecting the DLC Cable to the DLC on GM, Ford, and Chrysler vehicles are provided in the Mastertech kit. Adapters for connecting the Mastertech to other vehicles are provided in the optional program card or cartridge kits.

POWER SOURCES

The Mastertech is intended to be powered from the vehicle battery in one of the following ways:

- DC Power Cable and vehicle cigarette lighter socket.
- Directly from the battery via the DC Power Cable and the optional Battery Adapter Cable.
- Vehicle DLC via the DLC Cable (power is not available at the DLC on all vehicles).

The tester may also be powered in the following ways:

- AC Power Supply.
- Rechargeable battery pack.

BATTERY BACKED OPERATION

A rechargeable NiCad Battery pack is provided to power the tester under the following conditions:

- When the vehicle ignition is off
- While the engine is cranking
- Temporary off-vehicle “stand-alone” usage

Although the tester will operate on the battery pack, it is recommended that the tester is connected to the vehicle's 12-volt power supply during testing.

See [Chapter 8](#) for battery charging and replacement instructions.

BATTERY BACKED MEMORY

Tester configuration and data that has been captured during testing is retained in the tester battery backed memory under power from an onboard Lithium battery. This battery should last up to 2 years from the time of activation.

See [Chapter 4](#) for battery activation and [Chapter 8](#) for battery replacement instructions.

BEEPER

The tester contains an audio output device which can be used for user prompts, test begin and end indications, and error indications.

LEDs

Eight Light Emitting Diodes (LEDs), four red and four green, are located immediately below the display and are visible only when activated. The green light on the right is lit when the tester is in battery charge mode while the display is off.

In the display below, the green LED beneath KNOCK RETARD will be on when KNOCK RETARD is on and the red LED will be on when KNOCK RETARD is off.

For switched signals, such as A/C or Brake Switch, RED means OFF and GREEN means ON.

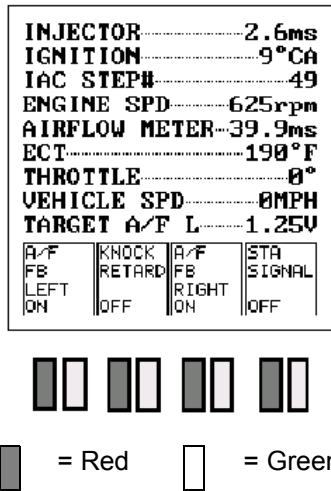

FIGURE 3-5. LEDs

INSTRUMENTATION PORT AND DEVICES

The Instrumentation Port (I/P) is used to connect the tester to one or more devices which are used to expand the diagnostic capability of the tester. The I/P connector receives signals which provide a serial communication link from “smart” instrumentation devices. These devices contain microprocessors which can perform specific diagnostic functions and send information to the tester.

The Instrumentation Port also contains circuits which can be used for making direct signal measurements. This capability is used to support instrumentation devices which may not require a microprocessor. The Diagnostic Test Lead set is an example of this type of instrumentation device.

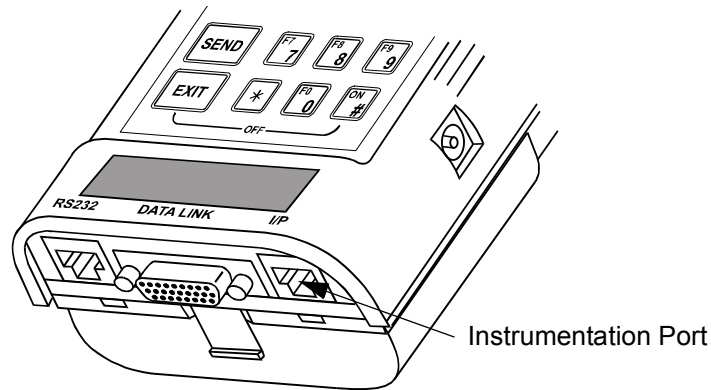

FIGURE 3-6. Instrumentation Port

DIAGNOSTIC TEST LEADS

The Diagnostic Test Leads provide a convenient means of signal input measurement.

The Diagnostic Test Leads are used for signal input to the DVM function which passively monitors voltage signals from the ECM/ECU, sensors, actuators, harness and connectors.

The Diagnostic Test Leads are also used for signal input to the oscilloscope, as well as timing (frequency, duty cycle, pulse width) measurements on vehicle signals.

NOTE

The Diagnostic Test Lead set provided in the Mastertech kit is only intended for automotive type signal measurement. It is not a lab-quality Digital Volt Ohm Meter (DVOM) or oscilloscope.

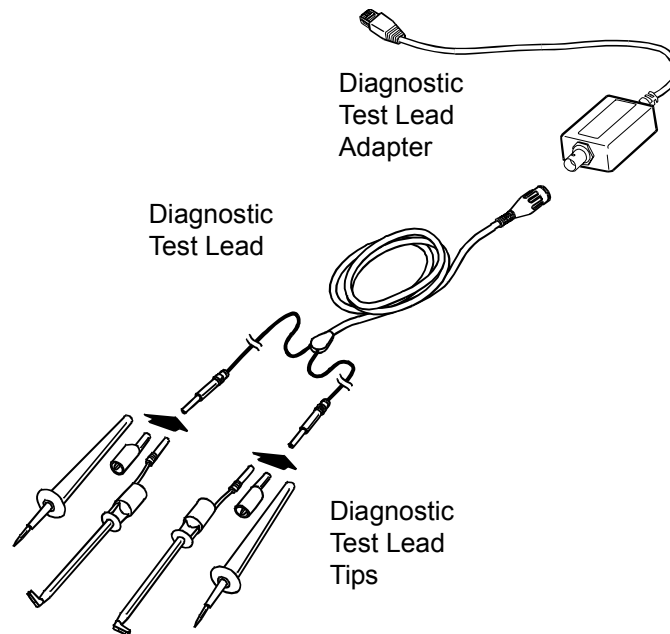

FIGURE 3-7. Diagnostic Test Lead Set and Test Lead Adapter

RS232 PORT AND RS232 PORT DEVICES

The Mastertech contains an RS232 Input/Output (I/O) serial data connection capable of supporting peripheral devices. The RS232 connection allows the tester to transfer and receive data to and from other RS232 compatible devices such as a remote host computer or serial printer.

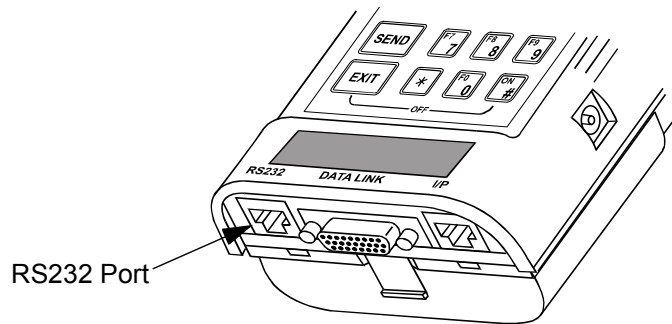

FIGURE 3-8. RS232 Port

REMOTE HOST COMPUTER

Using the RS232 port, the Mastertech can transfer and receive data to and from remote host computers including personal computers, computer-based test equipment at data rates up to 115.2k baud.

PRINTER

When the tester is connected to a compatible serial printer, such as the optional VP-411/VP-414, the following functions are available:

- Print diagnostic parameters
- Print trouble codes
- Print test results
- Print display information (including bar graphs and plots)

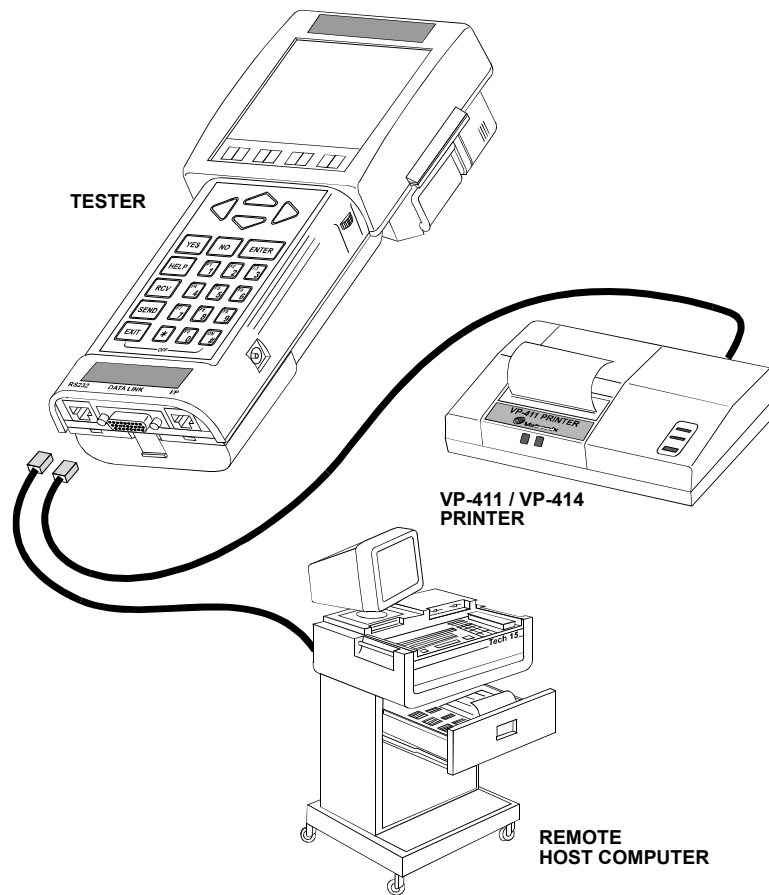
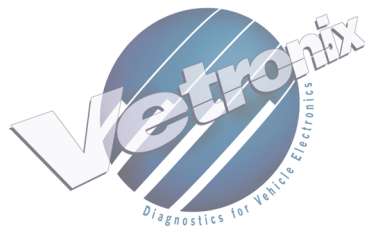

FIGURE 3-9. RS232 Port Devices

MASTERTECH CHARACTERISTICS

ITEM	CHARACTERISTIC
SIZE	10.2 x 27.9 x 5.1 CM (4.0 x 11.0 x 2.0 INCHES)
WEIGHT	1.02 KG (2.25 LBS) WITH BATTERY PACK
POWER	3.0 WATTS @ 12 VDC
INPUT VOLTAGE	6.5 TO 24 VDC (PROTECTED AGAINST REVERSE POLARITY)
KEYBOARD	23 KEY MEMBRANE
GRAPHIC DISPLAY	160 x 160 DOT GRAPHIC LIQUID CRYSTAL DISPLAY WITH BACK-LIGHTING
LED DISPLAY	8 LEDs (4 RED; 4 GREEN)
AUDIO OUTPUT	VARIABLE FREQUENCY BEEPER (200 Hz TO 10 kHz)
POWER SOURCES	<ul style="list-style-type: none"> • 12-VOLT VEHICLE POWER • NICAD BATTERY PACK (APPROXIMATELY 2 HOUR OPERATION) • LITHIUM BATTERY FOR CLOCK/ CALENDER AND RAM (APPROXIMATELY 2 YEAR LIFE)
PLUG-IN MODULES	<ul style="list-style-type: none"> • DIAGNOSTIC APPLICATION PROGRAM CARD • TECH 1 CARTRIDGE • I/O CARTRIDGE
OPERATING TEMP.	0° C TO 50° C (32° F TO 122° F)
STORAGE TEMP.	-20° C TO 60° C (-4° F TO 140° F)



4. ACTIVATING THE BATTERY BACKED MEMORY

Before using the Mastertech for the first time, the following steps must be performed in order to activate the NiCad battery pack and the Lithium battery.

1. To activate the NiCad battery pack, see [Figure 4-1](#). Remove the plastic strip that is visible on the back of the Mastertech. Remove the strip completely.

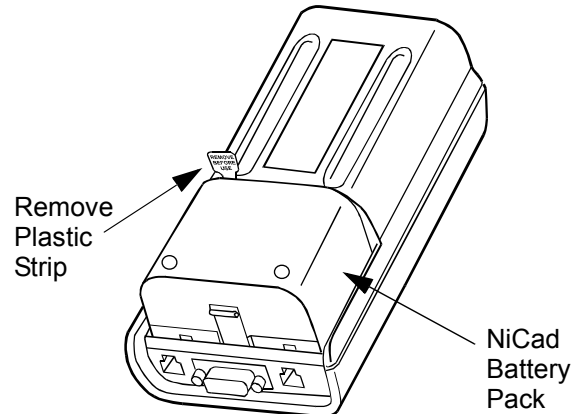

FIGURE 4-1. Activating NiCad Battery

2. To activate the Lithium battery, see [Figure 4-2](#) to remove the NiCad battery pack. Press on the tab at the bottom end of the battery pack while pulling the battery pack toward the bottom of the tester.

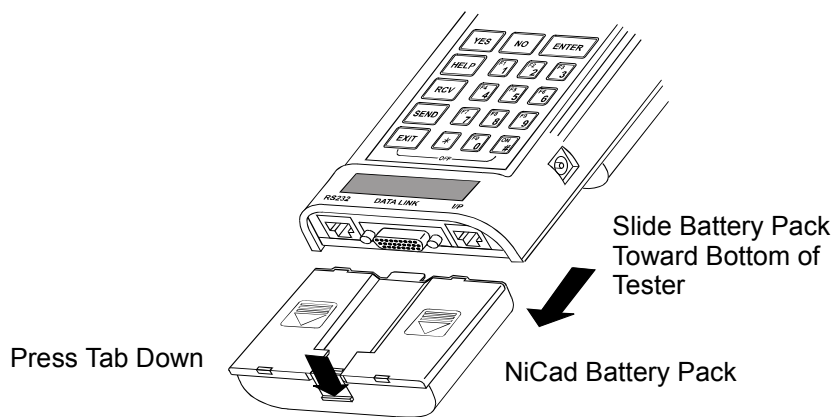

FIGURE 4-2. Activating Lithium Battery

3. See [Figure 4-3](#) to remove the plastic strip covering the Lithium battery on the back of the tester.

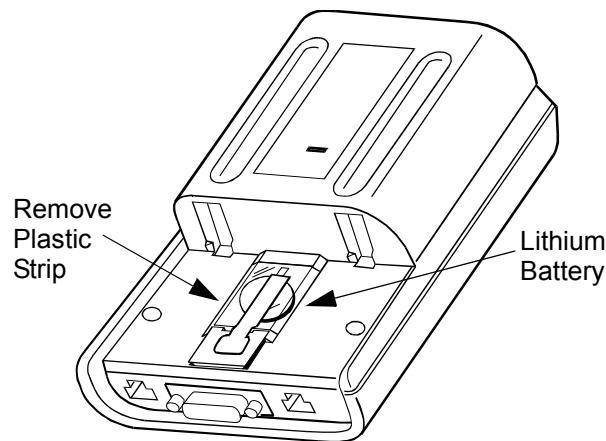

FIGURE 4-3. Removing Strip on Lithium Battery

4. When the plastic strip is removed, slide the battery pack onto the tester with the tab at the top in the slot on the tester. The battery pack should lock into place. For further information, see [Chapter 8](#).

5. See [Chapter 5](#) to install a program card in the Mastertech.

6. Press the **ON** key to turn the tester on. If the tester displays “ATTENTION! TESTER BATTERY VOLTAGE IS LOW,” see [Chapter 8](#) to charge the batteries.

7. The program card operator's manual explains how to setup the tester's internal functions. Some of the internal functions are listed below.

- CLOCK/CALENDAR
- SELECT BAUD RATE
- SELECT PRINTER
- UNIT CONVERSION

5. GETTING STARTED

INSTALLING A PROGRAM CARD OR CARTRIDGE

The Mastertech must be used in conjunction with a program card or Input/Output (I/O) cartridge, such as a TECH 1 Cartridge. The program card or cartridge contains the software that allows the tester to perform the tasks which are unique to diagnosing the various electronic control systems.

Be sure the Mastertech is off (press **#** **EXIT**) before installing or removing a program card or cartridge.

PROGRAM CARD

Hold the card so the flat surface is toward the face of the tester, then insert the card firmly into the slot located on the upper right side of the tester. The slot is keyed so the card can only be installed one way; don't force it if the cartridge doesn't slide in easily. When removing the program card, pull it straight out of the tester without rocking it up and down.

TECH 1 OR I/O CARTRIDGE

To install a TECH 1 or I/O cartridge, first remove the cover from the top rear of the tester. Insert the cartridge into the cartridge slot on the top rear of the tester while pressing the side tabs. Make sure the retaining hooks snap into place to provide a good, secure mating of the cartridge connector. Press on the side tabs when removing a cartridge from the tester. To prevent dirt from entering the tester, install the cover on the rear of the tester when a cartridge is not installed.

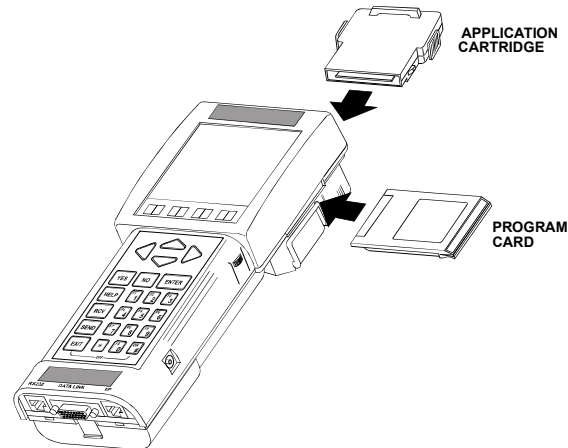

FIGURE 5-1. Installing Program Card and Cartridge

CONNECTING THE TESTER TO THE VEHICLE

The Mastertech kit contains the following cables and adapters to connect the tester to the vehicle.

- Data Link Connector (DLC) Cable
- DC Power Cable
- GM 12/14 Pin DLC Adapter
- Ford 7/14 Pin Adapter
- Chrysler 6/14 SCI DLC Adapter
- GM 5-Pin Adapter
- GM Pin-E Adapter

Refer to the Repair Manual or the electrical wiring diagram for the vehicle you are testing to determine the location and type of Data Link Connector (DLC) provided on the vehicle.

1. Connect the 26-pin end of the DLC cable to the bottom of the tester, then tighten the screws.
2. Depending on the vehicle make and the tests to be performed, connect the appropriate vehicle adapter to the end of the DLC cable.
3. Connect the other end of the vehicle adapter to the vehicle DLC.
4. Connect RS232 and Instrumentation Port devices that you plan to use to the Mastertech. RS232 devices, such as a printer, are connected to the bottom left side of the tester. Instrumentation devices such as the Diagnostic Test Lead connect to the bottom right side. The RS232 and I/P cable connectors are 10-pin RJ45 “phone” plugs that are keyed so they fit only the correct connector.

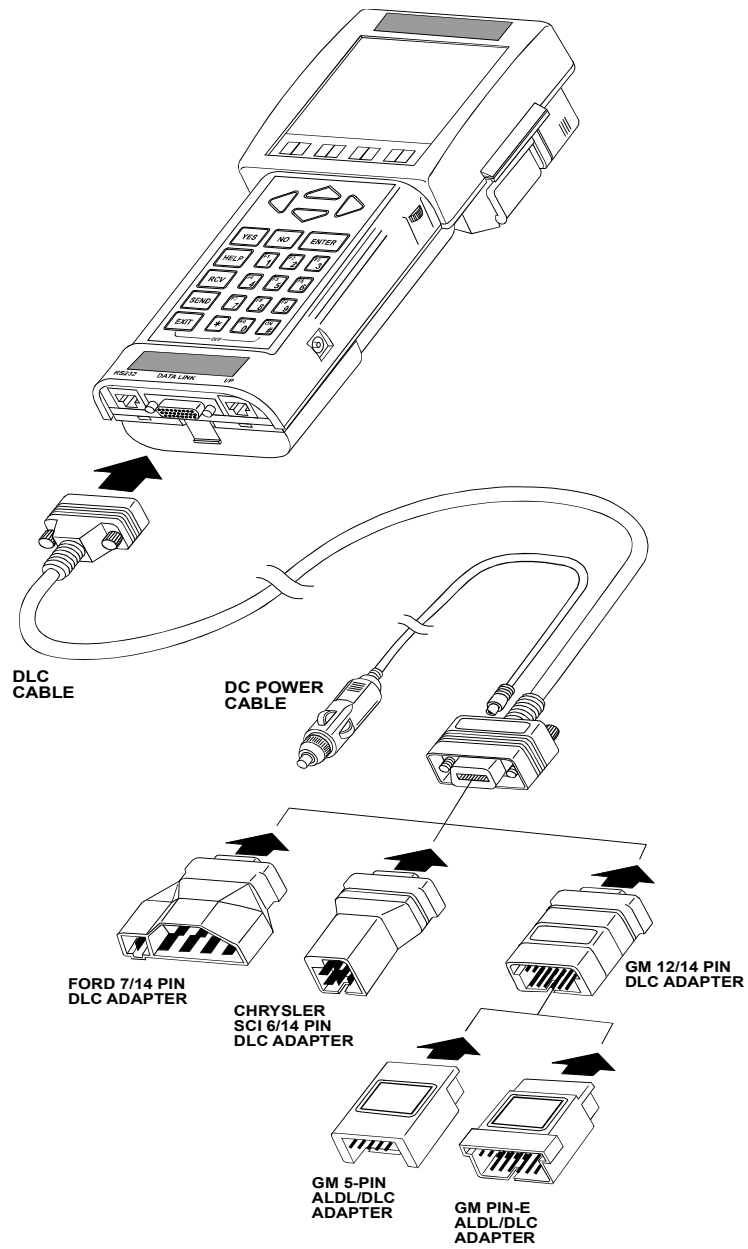

FIGURE 5-2. Mastertech Cable Connections

POWERING THE TESTER

The Mastertech can be powered by the vehicle 12-volt battery, by the AC 12-volt power supply, or by the internal battery pack.

NOTE



The right green LED is illuminated when the tester is connected to external power but has not been turned on.

VEHICLE BATTERY

- On some vehicle systems, the tester is powered directly by the DLC cable when the cable is connected to the vehicle DLC.
- If the tester is not powered directly by the vehicle DLC, connect the DC Power Cable to the right side of the tester or to the DC port on the 26-Pin end of the DLC Cable. Insert the cigarette lighter plug into the vehicle cigarette lighter socket or the optional Battery Adapter Cable.

To use the optional Battery Adapter Cable, connect the red clip to the positive (+) battery post and the black clip to the negative (-) post. Insert the cigarette lighter plug end of the DC Power Cable into the cigarette lighter socket on the Battery Adapter Cable.

AC 12-VOLT POWER SUPPLY

Connect the AC 12-volt power supply to the right side of the tester, then plug the power supply into a standard wall outlet.

BATTERY PACK

Press the **(ON)** key to power the tester via the internal battery pack. When the tester is powered by the battery pack, the display backlight will go off after one minute if there is no key press. The automatic shutoff preserves the battery charge. Once the backlight goes off, it can be turned on again by pressing any key.

NOTE



The battery pack is trickle charging when the tester is connected to any of the power sources listed above.

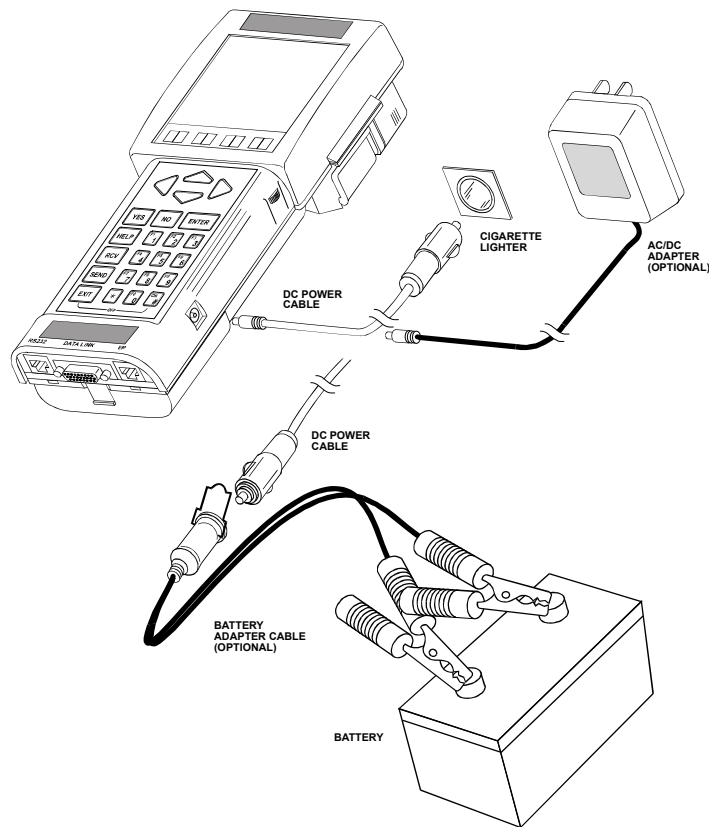

FIGURE 5-3. Powering the Mastertech

TURNING THE TESTER ON AND OFF

Connect the tester to one of the power sources listed above, then press the **ON** key.

The battery pack allows you to turn the tester on without being connected to external power. Simply press the **ON** key.

To turn the Mastertech off, press **#** **EXIT**, then release the **#** key before releasing the **EXIT** key.

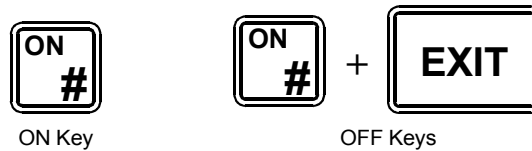

FIGURE 5-4. On and Off Keys

POWER-UP DISPLAY

Verify that the power up display for the program card or cartridge is correct. If the display is correct, follow the instructions in the program card or cartridge operator's manual.



FIGURE 5-5. Power-Up Display with Multi-Function Tester Program Card Installed

If the Mastertech is powered up without a program card or cartridge installed, the tester displays "NO PROGRAM CARD INSTALLED."

If the screen remains blank or something other than the Power-up screen is displayed, see [Appendix B](#).

HELP SCREENS

A list of the active keys for the screen displayed on the tester is available by pressing the **HELP** key. The HELP screens display information about which key to press to select a different mode, how to move the marker (cursor or highlight), print, or exit from the display. The example below illustrates the Key Help screen displayed when **HELP** is pressed while oscilloscope is active. For some functions, pressing \triangle will display additional information about the active function.

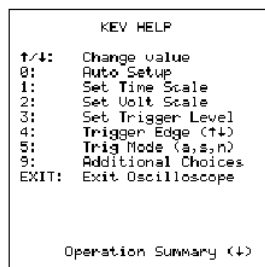

When **HELP** is pressed

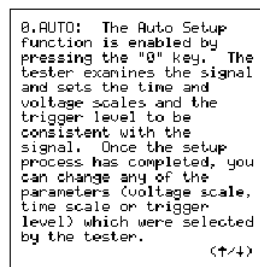

When \triangle is pressed

FIGURE 5-6. Help Screens

6. USING THE PORT CONNECTIONS

RS232 PORT

The RS232 port is a standard connection for communication between computers and computer peripherals such as printers and remote host computers. RS232 compatible equipment may be connected to the RS232 port via the 10-pin RJ45 connector located at the bottom left end of the tester.

The operation of the RS232 functions are dependent on the program card or cartridge and the RS232 device being used. Operating procedures for these functions are included in the operator's manuals for the program card or the RS232 device.

NOTE



One RS232 function which is common to all program cards is the “Screen Print” function. If you are using a compatible RS232 graphic printer, you can print what is displayed on the tester screen by pressing **# SEND**.

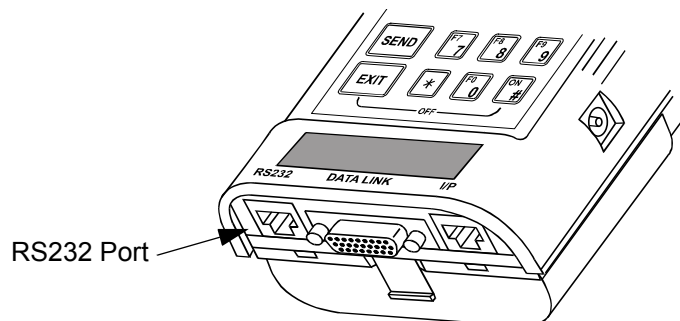

FIGURE 6-1. RS232 Port

INSTRUMENTATION PORT

The Instrumentation Port connection is a 10-pin RJ45 “phone plug” connector on the bottom right of the tester. The Instrumentation Port supports the use of the Diagnostic Test Leads and other I/P devices.

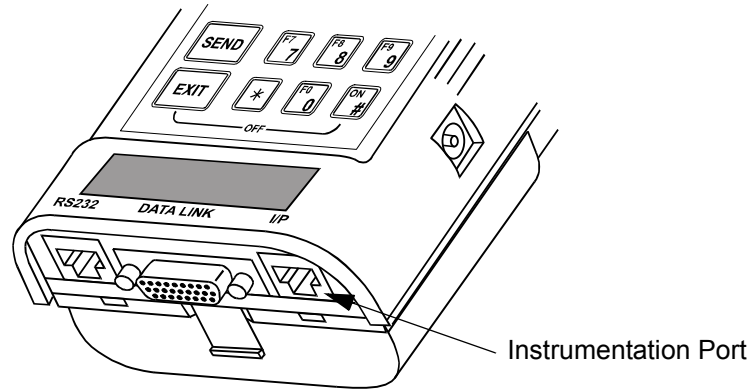

FIGURE 6-2. Instrumentation Port

DIAGNOSTIC TEST LEADS

Connect the Diagnostic Test Lead Adapter cable to the I/P connector on the bottom right end of the tester. Connect the Diagnostic Test Lead to the Test Lead Adapter. Install test lead tips (test pin probes, alligator clips, or insulation piercing hooks) onto the Diagnostic Test Lead. The Diagnostic Test Leads provide input to the following test capabilities:

- Digital Volt Meter
- Duty Cycle Measurement
- Frequency Counter
- Oscilloscope

NOTE



The Diagnostic Test lead set provided in the Mastertech kit is only intended for automotive-type signal measurement. It is not a lab-quality Digital Volt Ohm Meter (DVOM) or oscilloscope. Input voltage should not exceed ± 20 volts.

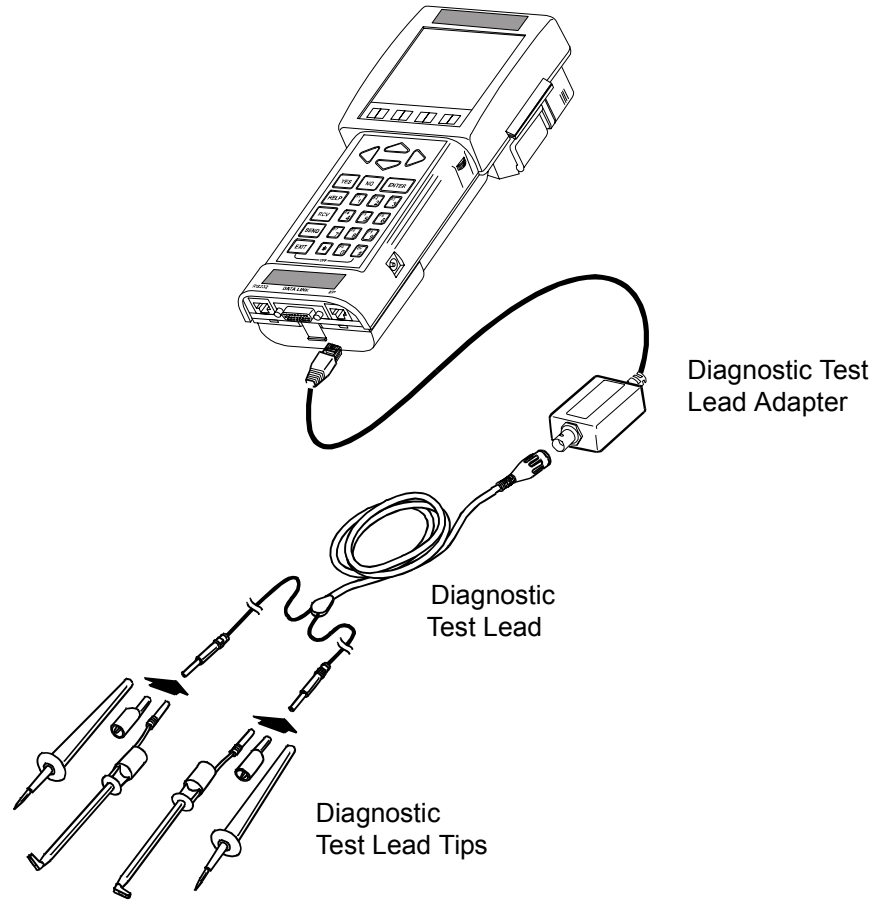

FIGURE 6-3. Diagnostic Test Lead Set and Adapter



7. FINISHING UP

After using the Mastertech, a few simple steps will help you leave the vehicle electronic system(s) in the proper state and also ensure that you get the most use out of your diagnostic tools:

1. Reconnect all hoses, connectors, spark plug wires, fuel lines, etc. that were disconnected from the vehicle during testing.
2. Before turning the tester off, clear any Diagnostic Trouble Codes that may have been set during the course of troubleshooting the vehicle electronic system(s).
3. Remove power to the tester by unplugging the DC power cable.
4. Disconnect the tester's connecting cables from the vehicle.
5. Turn the tester off by pressing **#** **EXIT** .
6. The program card and/or cartridge may be stored in the tester, or removed and stored in the program card slot in the storage case.

NOTE



If the Mastertech is turned on without a program card or cartridge installed, or with a different program card or cartridge installed, the data stored in the tester memory, such as Snapshot data, will be lost.

7. Inspect the cables, connectors, and cigarette lighter for damage and corrosion. Replace faulty components immediately.
8. Store the Mastertech, cables, and adapters in the storage case.

CLEANING AND STORING YOUR TESTER

If the Mastertech, test leads, adapters or cables become dirty, they may be cleaned by wiping them with a rag lightly coated with a mild detergent or non-abrasive hand soap. Do not immerse the tester, test leads,

adapters, or cables in water. Avoid using harsh solvents such as petroleum based cleaning agents, Acetone, Benzene, Trichloroethylene, etc. Although the tester and accessories are water resistant, they are not waterproof; thoroughly dry them prior to storage.

Always clean the tester screen by wiping vertically only. Never use a circular motion on clear plastics.

8. BATTERY CHARGING AND REPLACEMENT

The Mastertech contains two types of batteries: a set of rechargeable Nickel-Cadmium (NiCad) batteries and a replaceable Lithium battery.

NICAD BATTERY PACK

The NiCad batteries are housed in a removable battery pack located on the bottom underside of the tester. For normal use, the tester should be powered from the vehicle's cigarette lighter or battery adapter cable, or by the AC 12-volt adapter. However, on some vehicles power is not available at the cigarette lighter when the ignition is off or when the engine is cranking. The NiCad battery pack provides power to the tester under these conditions. When fully charged, the battery pack can power the tester for up to two hours.

CAUTION!



Always turn the Mastertech off when not in use!

To confirm that the battery pack is sufficiently charged for testing:

1. Turn the Mastertech on (press **ON**) before connecting the tester to an external power source such as the vehicle battery or AC 12-volt adapter.
2. If the screen below is displayed when powering the tester with the battery pack, the NiCad battery pack requires charging.

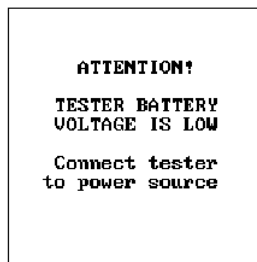

FIGURE 8-1. Low Battery Voltage Warning

CHARGING THE BATTERY PACK

The Mastertech constantly charges the NiCad battery pack as long as it is connected to a 12 VDC power source. In normal use, the tester will keep the battery pack adequately charged. However, if the tester is used for extended periods of time with the vehicle ignition off, or stored for an extended period of time without use, the NiCad battery pack may become discharged.

To recharge the battery pack, connect the tester to a 12 VDC power source such as the vehicle battery or the 12-volt AC/DC power supply or remove the six batteries from the battery pack and recharge the individual cells in a commercially available AA cell NiCad battery charger. It takes approximately 16 hours to fully recharge the battery pack. However, 4 hours of charging time will provide a partial charge and will allow approximately 30 minutes of tester operation.

Remember, the battery pack is required only when power is not available at the cigarette lighter socket. If the battery pack is not charged and you need to use the tester, simply connect the tester directly to the vehicle's battery with the Battery Adapter Cable and cigarette lighter DC power cable supplied with the tester kit. This will allow operation of all diagnostic procedures with the tester and will start recharging the battery pack at the same time.

It is recommended that the battery pack be charged overnight using the AC/DC power supply at least once a week (or more often if required). You can't charge the battery pack too often.

If "ATTENTION! TESTER BATTERY VOLTAGE LOW" is displayed after the battery pack has been properly charged, then the NiCad batteries are not capable of being recharged and must be replaced.

REPLACING THE NICAD BATTERIES

The capacity of the NiCad batteries will decrease over time and will need to be replaced periodically. The six batteries originally equipped with the tester are 1.2-volt High Capacity 600 milliampere hour (mAh), AA size, NiCad rechargeable batteries. This type of battery is available at certain electronic supply stores, or may be ordered from the nearest Vetronix Service Center listed in the Introduction. When replacing NiCad batteries, always replace all six cells. This will result in maximum battery life.

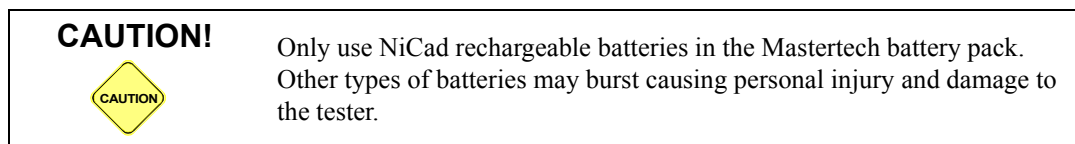

To replace the batteries:

1. Disconnect the power supply cable from the vehicle and from the tester.
2. Press **#** (**EXIT**) to turn the tester off.
3. Press the tab at the bottom end of the battery pack while pulling the battery pack toward the bottom of the tester.

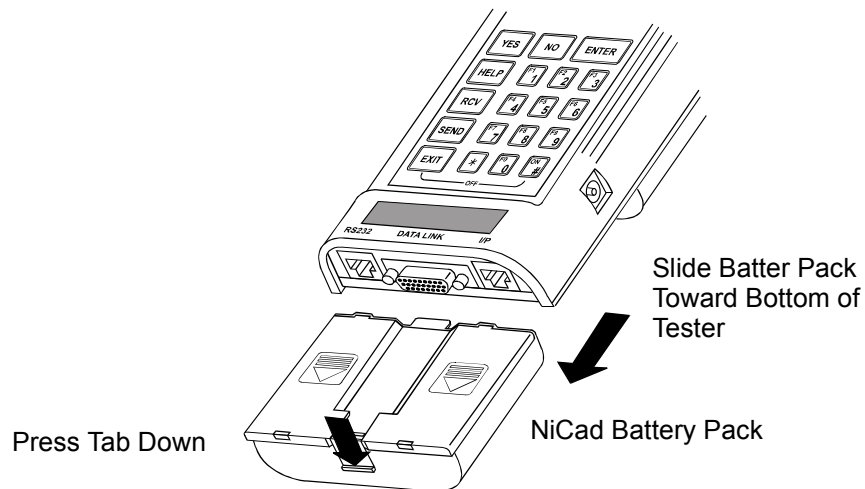

FIGURE 8-2. Removing the Battery Pack

4. To remove the battery pack cover, grasp the battery pack with one hand and position a screwdriver (flat blade) as shown in the figure below. Push the screwdriver blade against the battery pack side wall and the battery cover. While pushing, twist the screwdriver slightly until the cover pops loose from the locking tabs. Repeat for the other side.

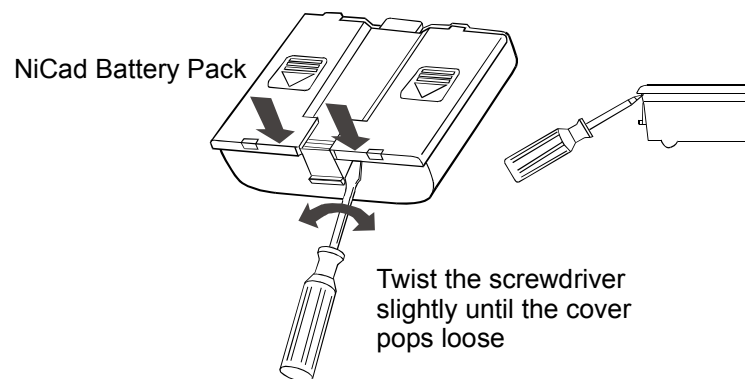

FIGURE 8-3. Removing the Battery Pack Cover

5. Remove the six NiCad batteries.

NOTE

NiCad batteries are recyclable. Under various state and local laws it may be illegal to dispose of NiCad batteries in the municipal waste system. Check with local solid waste officials in your area for recycling options or proper disposal methods.

6. Install new batteries with the positive (+) and negative (-) terminals oriented as indicated on the inside of the battery pack enclosure.
7. Place the cover on the battery case so the tabs at the top of the cover are aligned with the slots in the case, and the slots at the bottom of the cover are aligned with the tabs on the case.
8. Press the arrows on the battery cover while pushing the cover toward the top of the case. The cover should snap into place.
9. Slide the battery pack onto the tester so the tab at the top fits into the slot on the tester. The battery pack should lock into place.

LITHIUM BATTERY

The Lithium battery, located on the underside of the Mastertech behind the NiCad battery pack, enables the tester to retain setup information and data in its memory without being connected to an external power source.

The Lithium battery should last approximately two years before replacement is necessary. The tester displays the screen at left when the Lithium battery is discharged (dead) or a new battery has just been installed. This screen is also displayed if the plastic strips are not removed before operating the tester for the first time.

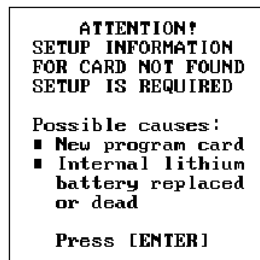

FIGURE 8-4. Lithium Battery Discharged Warning

REPLACING THE LITHIUM BATTERY

The Lithium battery is a standard 3-volt battery which must be replaced with a Sanyo CR2032 (or equivalent) battery when it becomes discharged.

1. Disconnect the power supply cable from the vehicle and from the tester.
2. Press **#** **EXIT** to turn the tester off.

3. The round Lithium battery is located under a plastic cover beneath the battery pack on the back of the tester.
4. To remove the NiCad battery pack, press the tab at the end of the battery pack while pulling the battery pack toward the bottom of the tester.
5. To remove the Lithium battery compartment plastic cover, use your fingernail or a small screwdriver to lift the bottom end of the cover away from the tester.
6. To remove the battery, gently lift up on the end of the metal strap that holds the battery in place. Note that the plus (+) side of the battery is toward you.
7. Remove the battery.

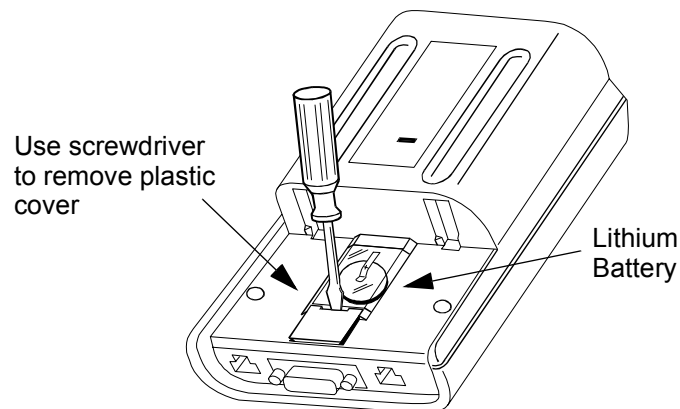
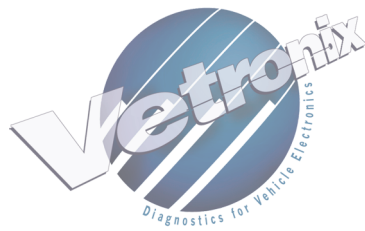

FIGURE 8-5. Removing the Lithium Battery

8. To install the new battery, lift the metal strap and insert the battery so the plus (+) side is facing you.
9. Install the plastic cover so the two plastic tabs on one end of the cover are hooked into the opening toward the top of the tester.
10. Press on the bottom end of the plastic cover until it snaps into place.
11. Slide the battery pack onto the tester so the tab at the top fits into the slot on the tester. The battery pack should lock into place.
12. Perform the Setup procedure described in the program card operator's manual.



A. UNDERSTANDING RS232 COMMUNICATIONS

RS232 is a standard in the computer industry for serial communications between computers and peripheral devices. Virtually all small computer systems have at least one RS232 port. RS232 links are used to communicate with printers, display terminals, modems and many types of test equipment.

An RS232 communication link is a serial link as opposed to a parallel link. This means that data is transmitted serially, one bit after another, over a single data line versus a number of bits being transmitted simultaneously using multiple data lines as is done in a parallel link. Remember that the RS232 connection will not work with a device which uses parallel data without a serial/parallel converter. This is important since most printers connected to small computer systems are parallel printers.

Specifications for the RS232 link are provided on the following page. You should not need to use this information unless you are trying to connect the tester to a device other than those discussed in this manual.

If you are trying to connect an RS232 compatible device to the Mastertech, you must make sure that you set it up so that it can communicate with the tester. If you're having problems, refer to the RS232 Interface Signal Specifications and use the following check list:

- Make sure the cable is connected
- Make sure the other device is "On Line"
- Make sure the baud rates are the same
- Make sure the data format is the same
- Make sure that the signals are connected appropriately between the two devices (the RS232 Transmit signal must be connected to the other device's Receive line and vice versa).

RS232 INTERFACE SIGNALS

PIN NUMBER	SIGNAL NAME	INPUT/OUTPUT	CONNECT TO:
1	NOT USED		
2	DTR	OUTPUT	DSR
3	CARRIER DETECT	INPUT	CARRIER DETECT
4	CTS	a	RTS
5	TRANSMIT	OUTPUT	RECEIVE
6	RECEIVE	INPUT	TRANSMIT
7	RTS	a	CTS
8	SIGNAL GROUND		SIGNAL GROUND
9	DSR	INPUT	DTR
10	NOT USED		

a. CTS and RTS are connected together inside the tester, but are not used as handshake signals by the tester.

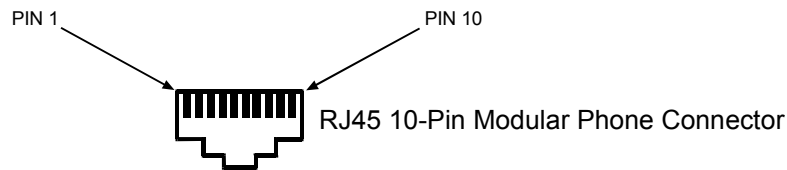

FIGURE A-1. RS232 Socket on Tester

SIGNAL LEVELS	DATA FORMAT	BAUD RATES
LOGIC "1" - 12 V 1 START BIT LOGIC "0" +12 V 8 DATA BITS	1 START BIT 8 DATA BITS 1 STOP BIT NO PARITY	SOFTWARE SELECTABLE: 1200 bps 2400 bps 4800 bps 9600 bps 19200 bps 38400 bps 57600 bps 115200 bps

TABLE A-1. RS232 Interface Specifications

B. IF YOU ARE HAVING A PROBLEM

If you have a problem using the Mastertech and the program card, first select SELF TEST from the program card SETUP MENU and perform all of the Self Tests.

This section is intended to help you get back on track if the Mastertech appears to be operating abnormally. Examples of most of the displays which you might see under abnormal conditions are shown. In addition, the most likely cause for the condition is given as well as other possible causes and recommendations on how to isolate or eliminate the problem. If your problem is not isolated or eliminated by using these instructions, see WARRANTY AND REPAIR INFORMATION in the Introduction section.

BLANK SCREEN WHEN TESTER IS TURNED ON

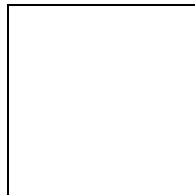

Most Likely Cause

- Display contrast misadjusted.
- NiCad batteries dead and tester is not receiving power from vehicle.
- Fuse in cigarette lighter plug is blown.

Recommendations

- Adjust tester contrast control.
- Charge NiCad batteries.
- Inspect the tester DC power cable and plug.
- Replace fuse in cigarette lighter plug (see 5: SYMPTOM).

ERROR MESSAGE IS DISPLAYED

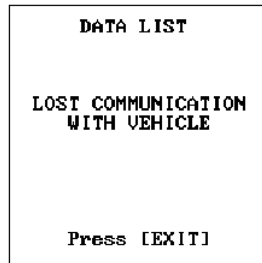

Most Likely Cause

- Vehicle ignition switch is turned off.
- Tester not connected to vehicle DLC.
- DLC adapter or cable is malfunctioning.
- Loose connections.

Recommendations

- Make sure vehicle ignition switch is in the ON position.
- Disconnect and reconnect the DLC, making sure the connector is properly connected.

PRINTER CANNOT PRINT BY PRESSING **SEND** AND **#** **SEND** KEYS

Most Likely Cause

- Printer is turned off.
- Printer is out of paper.
- Printer cable connections are loose or cable is open.
- Printer is malfunctioning.
- Printer setup is incorrect.
- Incompatible printer.

Recommendations

- Turn the printer power on.
- Verify that the printer baud rate is the same as the baud rate of the tester.
- Set paper on the printer.
- Make sure the printer cable is connected securely; replace printer cable as needed.
- Run the printer selftest or print to test.

MASTERTECH DOES NOT PASS ALL SELF TESTS

Most Likely Cause

- Tester is not receiving power from vehicle.
- Loose connections.
- Program card is not installed.
- Tester is connected to the vehicle DLC.
- Cigarette lighter socket or plug fuse is blown.

Recommendations

- Check that the cable is securely attached to the tester.
- Check that the DLC cable connector pins are clean.
- Check the fuse for the cigarette lighter socket and the fuse in the cigarette lighter plug. Replace the fuses if necessary.
- Double check that the appropriate test adapter (required for certain tests) is properly installed and making good contact during the testing.

MASTERTECH FAILS TO POWER UP

Most Likely Cause

- DC power cable not making good contact.
- Vehicle cigarette lighter fuse is blown.
- Fuse in DC power cable cigarette lighter plug is blown.

Recommendations

- Disconnect and reconnect the DC power cord. Verify that the power cord is connected properly.
- Replace vehicle cigarette lighter fuse.
- Replace fuse in DC power cable cigarette lighter plug as follows:
 - a. Disconnect the DC power cable from the tester.
 - b. A 3A fuse is built into the power plug on the DC power cable.
- Check and replace the fuse as follows:
 - a. Remove the power plug cover and remove the fuse together with the spring. The spring and power plug terminal can pop out so take care not to lose them.
 - b. Check the fuse and replace it if necessary.
 - c. Install the fuse and spring into the power plug.
 - d. Check that the power plug terminal is inside the power plug cover, then screw the cover onto the power plug.

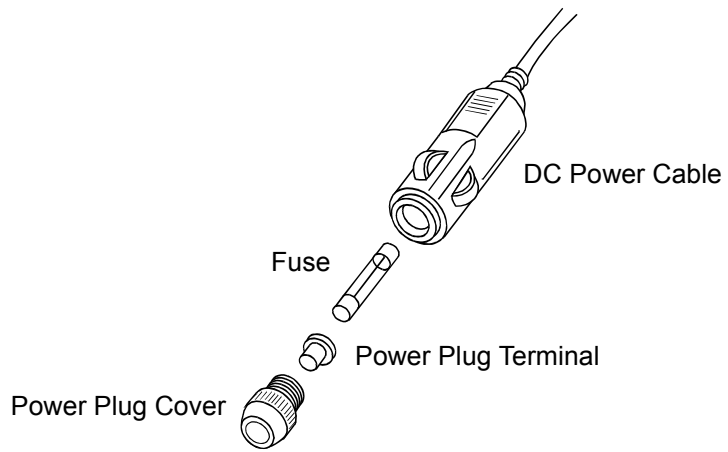

FIGURE B-1. DC Power Cable Plug

C. GLOSSARY AND ABBREVIATIONS

TERM	DEFINITION
AC	Alternating Current
BAUD RATE	The speed at which data is transferred over a serial data link.
bps	Bits per second. Unit used for baud rate.
CURSOR	Highlighted text or data on the display screen. Same as Marker.
DATA LIST	A mode of operation. Basic diagnostic data parameters are displayed on the tester.
DC	Direct Current
DCE	Data Communication Equipment. A term used to describe a device connected to an RS232 link.
DLC	Data Link Connector
DTE	Data Terminal Equipment. A term used to describe a device connected to an RS232 link.
DVM	Digital Volt Meter
DVOM	Digital Volt Ohm Meter
ECM	Engine Control Module
ECU	Electronic Control Unit
EEPROM	Electrically Erasable PROM
Hz	Hertz. A unit of measure for frequency.
I/F	Interface
I/O	Input/Output
I/P	Instrumentation Port

TERM	DEFINITION
LED	Light Emitting Diode
MARKER	Highlighted text or data on the display screen. Same as Cursor.
NICAD	Nickel Cadmium rechargeable batteries.
O2	Oxygen
OBD	On Board Diagnostics
RCV	Receive
RJ45	A modular phone connector.
RS232	Same as RS232C.
RS232C	The most standard serial communication interface used in the computer industry.
SCI	Serial Communication Interface
SCREEN PRINT	An operating mode of the RS232 where the tester display is sent to a printer.
SNAPSHOT	A mode of operation. In the SNAPSHOT mode, basic diagnostic data parameters are stored in the tester during a road test and can be examined, printed or transferred to a computer at the end of the test.
VDC	Volts DC

INDEX

A

adapters 3-1, 3-6, 5-2

B

backlight 5-4

battery

lithium

activating 4-1
description 3-7, 8-4
replacing 8-4

NiCad battery pack

activating 4-1
charging 8-2
description 8-1
powering 5-4
replacing 8-2
testing 8-1
usage 3-7

vehicle 5-4

battery adapter cable 5-4, 8-2

blank screen display B-1

C

cables 3-1, 5-2

cartridge

description 3-3
installing 5-1

cautions 1-2

D

diagnostic test leads

cautions 1-2

connecting 6-2

description 3-10

usage 2-1

display

contrast 3-6

Tech 1 1-1

E

enhanced mode display 1-2

error message display B-2

H

help screens 5-6

I

instrumentation port 3-9, 6-2

K

keypad 1-2, 3-4

L

light emitting diodes (LEDs) 3-8

M

Mastertech

cleaning 7-1

description 2-1

shutting down 7-1

Mastertech kit
 components [3-1](#), [5-2](#)
 description [2-1](#)
Matertech
 self tests [B-1](#)

N

notes [1-2](#)

P

power source [3-7](#)
power up failure [B-3](#)
precautions [1-2](#)
printer [3-12](#)
printer failure [B-2](#)
program card
 installing [3-3](#), [5-1](#)

R

RS232 communication [A-1](#)
RS232 port [3-11](#), [6-1](#)

S

self tests
 failure [B-3](#)
 perform [B-1](#)

T

tester. See Mastertech
troubleshooting [B-1](#)

W

warnings [1-2](#)
warranty [1-3](#)